

99854

Design

SKF Speedi-Sleeve Gold

Dimensions

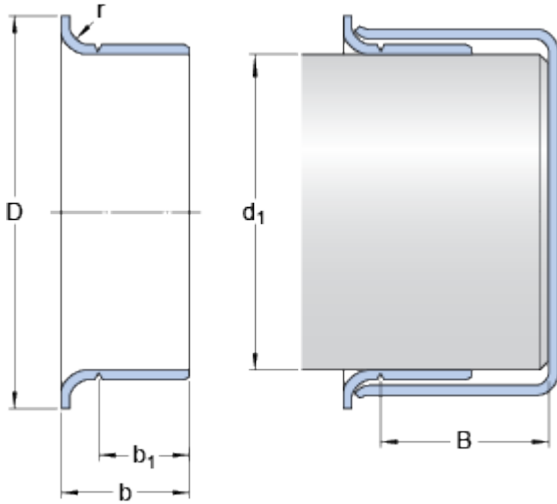

Nominal dimensions

d_1		100.025	mm
D		109.55	mm
Tolerance outside diameter D	\pm	1.6	mm
b		25.4	mm
Tolerance width b	\pm	0.8	mm
b_1		20.65	mm
Tolerance width b_1	\pm	0.8	mm
B	max.	52.07	mm
r	max.	3.18	mm

Shaft diameter range

d_1	min.	99.949	mm
d_1	max.	100.127	mm